

LED  
PRODUCT

 **enzo** Power  
The Wonderland of Life  
Power**enzo**.com

 **nzo** Power  
The Wonderland of Life  
Power**enzo**.com



## About Enzo LiGHT

ENZO LIGHT Company was found in 2015, is a comprehensive enterprise focusing on R&D, manufacturing, marketing, lighting design and project solution of LED lamps and luminaires. ENZO LIGHT Co. is one of the top lighting manufacturers in Iran, Iraq and UAE markets. For many years of independent research and development along with close cooperation with domestic academic institutions, ENZO LIGHT is dedicated to R&D of lighting products.

ENZO LIGHT Co. owns powerful engineering department, including R&D engineers, skilled QC team and well trained testing staffs.

By virtue of excellent technology, reliable quality and great after sales services; our company has built a high reputation in domestic and abroad markets, and gained full authorized certification included ISO 9001, 2015 International management system certification and IEC60958



**LED  
BULB SERIES**







LED Bulb

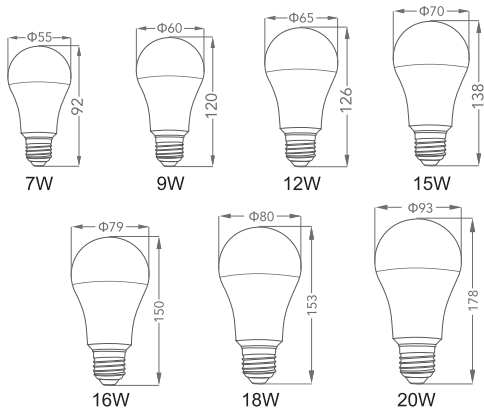

Model	A55	A60	A65	A70	A70	A80	A95
Power	7	9	12	15	16	18	20
Luminous flux	630	860	1150	1350	1425	1620	1900
CCT(K)	3000K / 6500K						
Input Voltage	100~265VAC 50-60Hz						
CRI	80						



Colorful Bulb LED

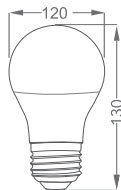

Model

A60

Power

9

CCT(K)

Blue, Green, Orange, Red, Yellow

Input Voltage

135~250VAC 50-60Hz



**LED T-BULB  
ALUMINIUM**

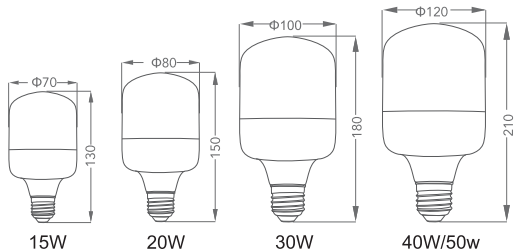

Model	T-Bulb				
Power	15	20	30	40	50
Luminous flux	1350	1800	2700	3600	4500
CCT(K)	6500K				
Input Voltage	100~265VAC 50-60Hz				
CRI	80				



LED T-BULB  
ALUMINIUM

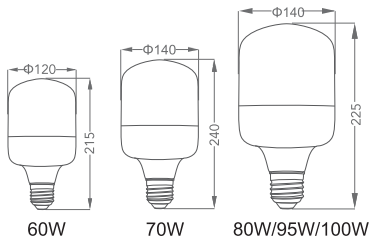

Model	T-Bulb				
Power	60	70	80	95	100
Luminous flux	5400	6300	7200	8550	9000
CCT(K)	6500K				
Input Voltage	100~265VAC 50-60Hz				
CRI	80				





1200MAH WITHOUT USB



1800MAH WITH USB

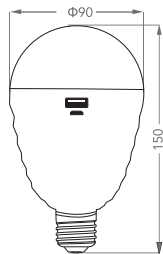

18W

Model

Emergency & Rechargeable

Power

18

Luminous flux

1620

CCT(K)

3000K / 6500K

Input Voltage

85~265VAC 50-60Hz

CRI

80



CAP/E27

Magnolia

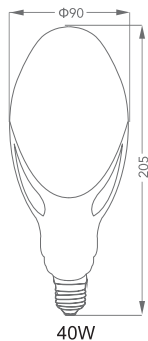
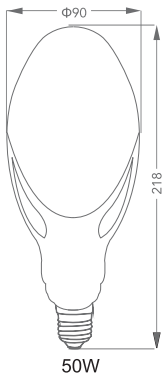

Model

Magnolia

Power

40

50

Luminous flux

3800

4100 / 4400

CCT(K)

3000K / 6500K

Input Voltage

165~265VAC 50-60Hz

CRI

80



CAP/E27

LED UFO long neck

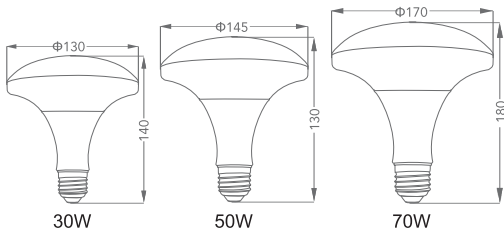

Model	LED UFO long neck		
Power	30	50	70
Luminous flux	2450	4250	6000
CCT(K)	3000K / 6500K		7000K
Input Voltage	100~265VAC 50-60Hz		
CRI	80		



Football LED

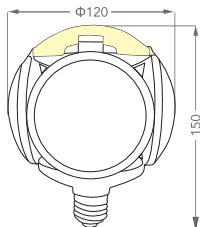

40W

Model

**BUFO**

Power

40

Luminous flux

2400

CCT(K)

3200K / 4000K / 7000K

Input Voltage

85~265VAC 50-60Hz

CRI

80





Bulb Four-blade 4x1 LED

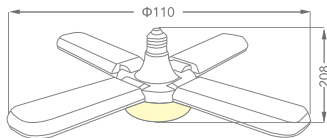

40W / 50W

Model	YPD3
Power	40 / 50
Luminous flux	4000
CCT(K)	4000K / 7000K
Input Voltage	85~265VAC 50-60Hz
CRI	80



LED BULB - SED

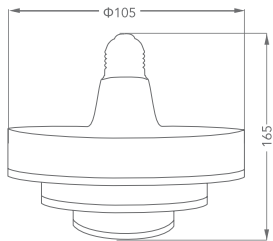

30W

Model

SED

Power

30

Luminous flux

2400

CCT(K)

3000K / 8000K

Input Voltage

85~265VAC 50-60Hz

CRI

80



CAP/E27

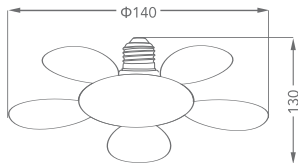
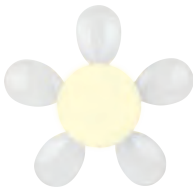

40W

LED BULB - HDD

Model	HDD
Power	40
Luminous flux	3200
CCT(K)	4000K / 8000K
Input Voltage	85~265VAC 50-60Hz
CRI	80



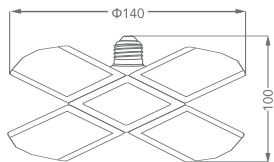

30W

LED BULB - FXD

Model	FXD
Power	30
Luminous flux	2400
CCT(K)	4000K / 6500K
Input Voltage	85~265VAC 50-60Hz
CRI	80



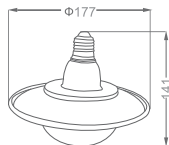

40W

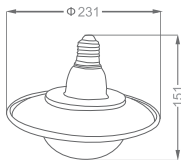

50W

**GOLDEN+GOLDEN**  
BASE

**ROSE+ROSE**  
BASE

**RED+GOLDEN**  
BASE

**WHITE+GOLDEN**  
BASE

**SILVER+GOLDEN**  
BASE

**BLACK+GOLDEN**  
BASE

LED UFO

Model	LED UFO	
Power	40	50
Luminous flux	3600	4700
CCT(K)	6500	
Input Voltage	145~265V Ac/50-60Hz	
CRI	80	



CAP/E27



**LED  
DOWN LIGHT  
SERIES**



Downlight LED

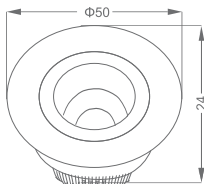

4W  
Cutting size  
Φ45

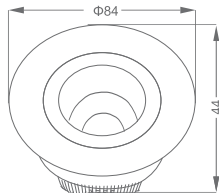

5W  
Cutting size  
Φ70

Model	KOD-THD 403	
Power	4	5
Luminous flux	320	420
CCT(K)	3000K / 6500K	
Input Voltage	85~265VAC 50-60Hz	
CRI	80	

**nzo Power**  
The Wonderland of Life



Downlight LED

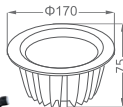

20W  
Cutting size  
Φ150

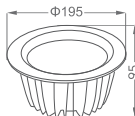

30W  
Cutting size  
Φ165

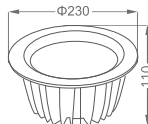

45W  
Cutting size  
Φ210

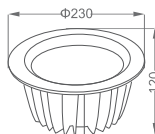

60W  
Cutting size  
Φ210

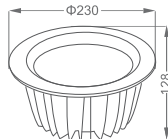

80W  
Cutting size  
Φ210

Model	216R				
Power	20	30	45	60	80
Luminous flux	1900	3113	4265	5777	8498
CCT(K)	3000K / 6500K				
Input Voltage	100~265VAC 50-60Hz				
CRI	80				



Downlight LED

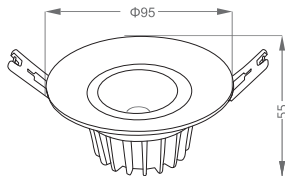

7W  
Cutting size  
 $\Phi 75$

Model	GGL-304
Power	7
Luminous flux	602
CCT(K)	3000K / 6500K
Input Voltage	85~265VAC 50-60Hz
CRI	80



LED DOWN LIGHT

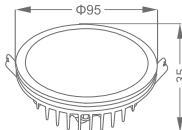

9W  
Cutting size /  $\Phi 75$

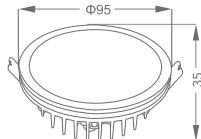

16W  
Cutting size /  $\Phi 95$

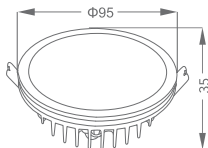

20W  
Cutting size /  $\Phi 120$

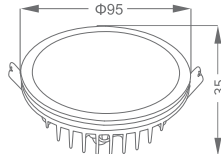

30W  
Cutting size /  $\Phi 145$

Model	<b>GGL-218B</b>			
Power	<b>9</b>	<b>16</b>	<b>20</b>	<b>30</b>
Luminous flux	<b>785</b>	<b>1439</b>	<b>1864</b>	<b>2855</b>
CCT(K)	<b>3000 / 6500</b>			
Input Voltage	<b>100~265VAC 50-60Hz</b>			
CRI	<b>80</b>			



LED DOWN LIGHT

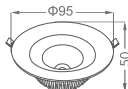

7W  
Cutting size  
Φ75

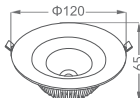

12W  
Cutting size  
Φ100

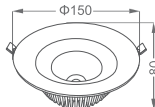

18W  
Cutting size  
Φ120

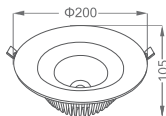

30W  
Cutting size  
Φ170

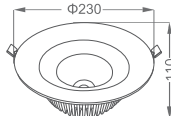

50W  
Cutting size  
Φ200

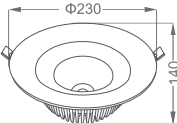

65W  
Cutting size  
Φ200

<b>Model</b>	<b>GGL-214B</b>					
<b>Power</b>	<b>7</b>	<b>12</b>	<b>18</b>	<b>30</b>	<b>50</b>	<b>65</b>
<b>Luminous flux</b>	<b>525</b>	<b>1080</b>	<b>1620</b>	<b>2700</b>	<b>4600</b>	<b>6175</b>
<b>CCT(K)</b>	<b>3000K / 6500K</b>					
<b>Input Voltage</b>	<b>100~265VAC 50-60Hz</b>					
<b>CRI</b>	<b>80</b>					



LED DOWN LIGHT

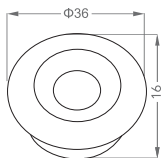

12W  
Cutting size  
 $\Phi 30$

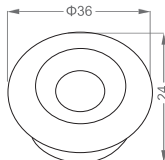

50W  
Cutting size  
 $\Phi 30$

Model	RML-261A	RML-260A
Power	12	50
Luminous flux	70	200
CCT(K)	3000K / 6500K	
Input Voltage	90~265VAC 50-60Hz	
CRI	80	

LED DOWN LIGHT

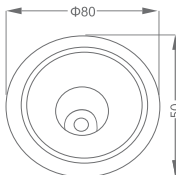

7W  
Cutting size  
Φ80

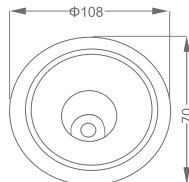

7W  
Cutting size  
Φ108

Model	RML-261A	RML-260A
Power	5	12
Luminous flux	350	960
CCT(K)	3000K / 6500K	
Input Voltage	100~240VAC 50-60Hz	
CRI	80	

LED DOWN LIGHT

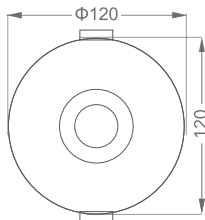

8+8W / 12W  
Cutting size  
45-80

Model	Color Changeable	Color Changeable 2 in 1
Power	8+8	12
Luminous flux	80	80
CCT(K)	PINK+7000+3500	
Input Voltage	85~265VAC 50-60Hz	
CRI	80	

3  
Steps

2 IN 1



**LED  
PANEL LIGHT  
SERIES**

Back light Panel LED

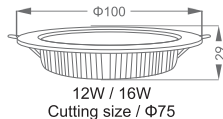
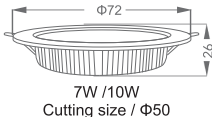
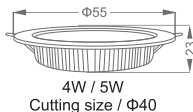

<b>Model</b>	<b>GGL-116B</b>		
<b>Power</b>	<b>3</b>	<b>5</b>	<b>7</b>
<b>Luminous flux</b>	<b>130</b>	<b>288</b>	<b>448</b>
<b>CCT(K)</b>	<b>3200K / 7000K / 8000K</b>		
<b>Input Voltage</b>	<b>85~265VAC 50-60Hz</b>		
<b>CRI</b>	<b>80</b>		





**Back light Panel LED**



4W  
Cutting size / Φ50



10W  
Cutting size / Φ75

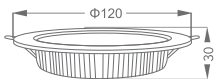

16W  
Cutting size / Φ95

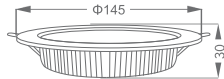

20W  
Cutting size / Φ120 / 200

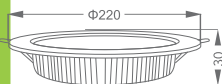

24W  
Cutting size / Φ200

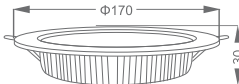

25W  
Cutting size / Φ200

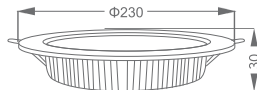

32W  
Cutting size / Φ145

**Model**

**ZH-R041A**

**Power**

**4**

**10**

**16**

**20**

**24**

**25**

**32**

**Luminous flux**

320/340

800/850

1280/1360

1600/1700

1920

2000/2125

2560/2750

**CCT(K)**

**3000 / 6500**

**4000 / 7000 / 8000**

**Input Voltage**

**85-100~265VAC 50-60Hz**

**CRI**

**80**

LED PANEL LIGHT

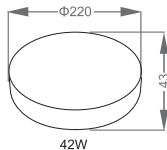
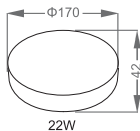

Model	PA15-R22	PA15-R42
Power	22	42
Luminous flux	1540	3360
CCT(K)	6500	
Input Voltage	100~240VAC 50-60Hz	
CRI	80	

Panel LED

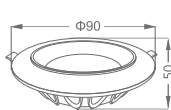

6W  
Cutting size  
Φ70

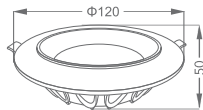

12W  
Cutting size  
Φ95

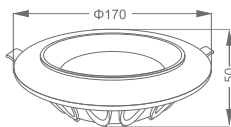

22W  
Cutting size  
Φ130-140

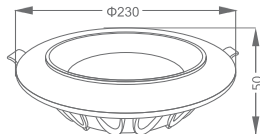

32W  
Cutting size  
Φ185-190

Model	RBY06	RBY12	RBY22	RBY32
Power	6	12	22	32
Luminous flux	480 / 510	840	1540	2240
CCT(K)	3000K / 6500K			
Input Voltage	100~265VAC 50-60Hz			
CRI	80			

LED PANEL LIGHT

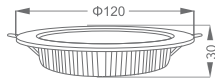

12/16W  
Cutting size /  $\Phi 95$



25/32W  
Cutting size /  $\Phi 160$

Model	RA			
Power	12	16	25	32
Luminous flux	960	1280	2000	2400
CCT(K)	3000K / 6500K			
Input Voltage	100~265VAC 50-60Hz			
CRI	80			



LED PANEL LIGHT

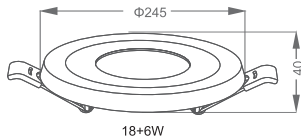
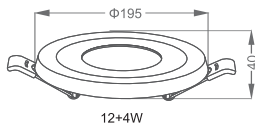
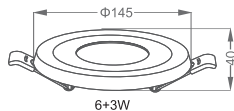
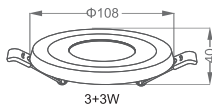

Model	UR-MSEA06	UR-MSEA09	UR-MSEA16	UR-MSEA24
Power	3+3	6+3	12+4	18+6
Luminous flux	120	250	550	900
CCT(K)	3000K / 8000K			
Input Voltage	85~265VAC 50-60Hz			
CRI	80			

3  
Steps

**3  
IN  
1**

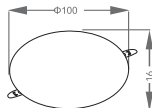

10W  
Cutting size  
Φ50-70

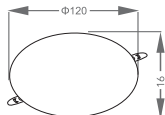

18W  
Cutting size  
Φ50-95

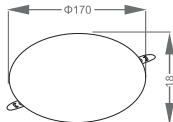

24W  
Cutting size  
Φ50-140

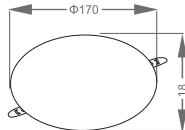

36W  
Cutting size  
Φ50-140

## LED Panel

Model	BH-TP10	BH-TP18	BH-TP24	BH-TP36
Power	10	18	24	36
Luminous flux	540	1800	2400	3600
CCT(K)	3000K / 4000 / 8000K			
Input Voltage	130~265VAC 50-60Hz			
CRI	80			

LED Adjustable Panel  
PD MODEL

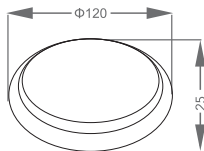

12W  
Cutting size  
Φ75-105

Model	PD-MODEL
Power	12
Luminous flux	113.6
CCT(K)	3000K / 8000K
Input Voltage	85~265VAC 50-60Hz
CRI	80

LED PANEL 60\*60

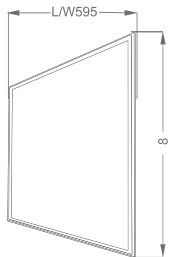

50W

<b>Model</b>	<b>Panel 60x60</b>	
<b>Power</b>	<b>50</b>	<b>70</b>
<b>Luminous flux</b>	<b>4820</b>	<b>5760</b>
<b>CCT(K)</b>	<b>3200K / 4000K / 7000K</b>	<b>3200K / 7000K</b>
<b>Input Voltage</b>	<b>85~265VAC 50-60Hz</b>	
<b>CRI</b>	<b>80</b>	



LED PANEL 60\*60

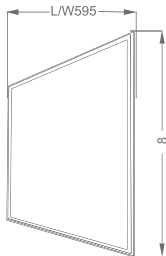
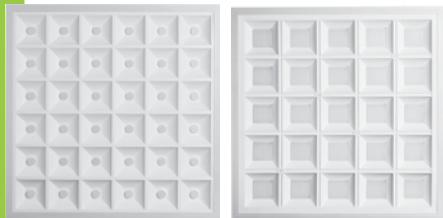

Model	ART 60W-25 Square lens	ART 96W-25 Square lens	ART 120W-25 Square lens	ART 60W-25 round lens
Power	60	96	120	60
Luminous flux	7200	11520	14400	7200
CCT(K)	3200K / 7500K			
Input Voltage	185~265VAC 50-60Hz			
CRI	80			



**LED  
Bulkhead  
SERIES**

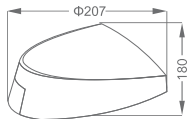

24+2W

LED WALL LIGHT

Model	FH-WL-T	
Power	24+2	
Luminous flux	1440	
CCT(K)	3200K / 6500K	
Input Voltage	100~240VAC 50-60Hz	
CRI	80	

Shell Color  
Black ●  
White ○



LED DOWN LIGHT  
Surface Round

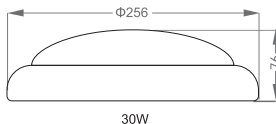
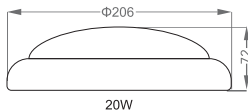

Model	LPDL-20A-Y	LPDL-30A-Y
Power	20	30
Luminous flux	1600	2400
CCT(K)	3000 / 7000 / 8000	
Input Voltage	220~240VAC 50-60Hz	
CRI	80	



LED DOWN LIGHT  
Surface oval

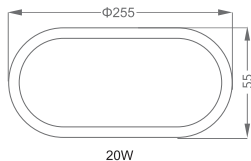

Model	LPDL-20A-Y
Power	20
Luminous flux	1600
CCT(K)	3000 / 7000 / 8000
Input Voltage	220~240VAC 50-60Hz
CRI	80



Ceiling light LED  
Surface Mount Oval

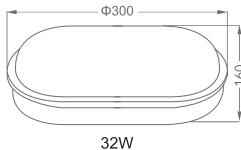
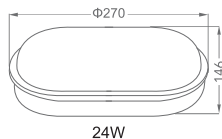
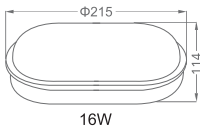

Model	BH-O-001	BH-O-002	BH-O-003
Power	16	24	32
Luminous flux	1280	1920	2560
CCT(K)	3000 / 6500		
Input Voltage	220~240VAC 50-60Hz		
CRI	80		



Ceiling light LED  
Surface Mount Round

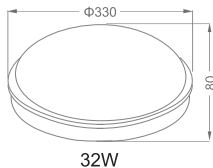
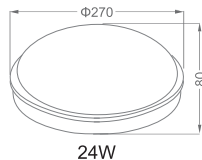
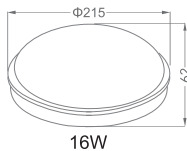

Model	BH-R-001	BH-R-002	BH-R-003
Power	16	24	32
Luminous flux	1280	1920	2560
CCT(K)	3000 / 6500		
Input Voltage	220~240VAC 50-60Hz		
CRI	80		



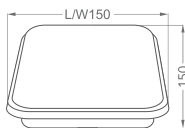

15W

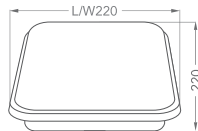

20W

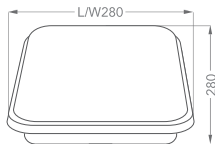

30W

Ceiling light LED  
Surface Mount Square

Model	BH-S-001	BH-S-002	BH-S-003
Power	15	20	30
Luminous flux	1200	1800	2400
CCT(K)	3000 / 6500		
Input Voltage	220~240VAC 50-60Hz		
CRI	80		





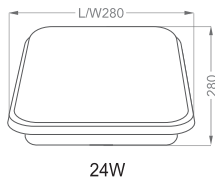

290x145x75

**Bulkhead  
king 24**

<b>Model</b>	<b>king 24</b>
<b>Power</b>	<b>24</b>
<b>Luminous flux</b>	<b>2280</b>
<b>CCT(K)</b>	<b>8000K</b>
<b>Input Voltage</b>	<b>85~265VAC 50-60Hz</b>
<b>CRI</b>	<b>80</b>





LED  
LINEAR  
SERIES

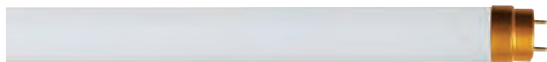

24W / 18W / 30W

Model	T8E0218 / 865	T8E0209 / 860	T8E0230 / 765
Power	24	18	30
Luminous flux	2700	1800	2940
CCT(K)	3000K / 6500K		
Input Voltage	85~265VAC 50-60Hz		
CRI	80		

**CAP  
2G11**



**LED linear**

Model	MFPL1002	MXL3004	MXL2056
Power	30	60	100
Luminous flux	2400	4800	8000
CCT(K)	3000K / 6500K		
Input Voltage	85~265VAC 50-60Hz		
CRI	80		

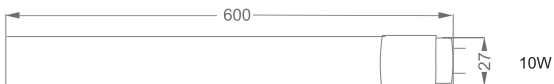

10W



18W / 30W

T8 Light PC Cap

Model		T8	
Power	10	18	30
Luminous flux	900	1440	3000
CCT(K)	3000 / 6500		
Input Voltage	160~265VAC 50-60Hz		
CRI	80		

A photograph of an elephant standing in a shallow lake at dusk. The scene is bathed in a teal/cyan light, with the elephant's reflection clearly visible in the water. In the background, there are rolling hills under a cloudy sky. The right side of the image is split vertically, showing a grayscale version of the same scene. The text 'LED FLOOD LIGHT SERIES' is overlaid in white, bold, serif font on the teal portion of the image.

**LED  
FLOOD LIGHT  
SERIES**

Flood light LED

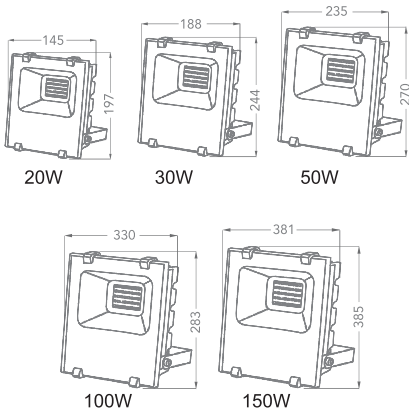

Model	FL-SMD-20	FL-SMD-30	FL-SMD-50	FL-SMD-100	FL-SMD-150
Power	20	30	50	100	150
Luminous flux	1600	2400	4000	8000	12000
CCT(K)	3000 / 6500				
Input Voltage	90~265VAC 50-60Hz				
CRI	80				



Flood light LED

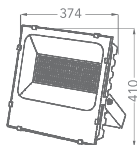

200W

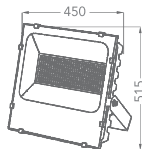

300W

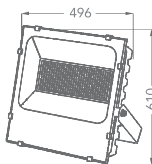

400W

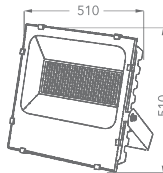

500W

Model	FL-SMD-200	FL-SMD-300	FL-SMD-400	FL-SMD-500
Power	200	300	400	500
Luminous flux	16000	24000	32000	40000
CCT(K)	3000 / 6500			
Input Voltage	90~265VAC 50-60Hz			
CRI	80			





Flood light RGB LED

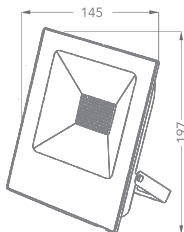

20W

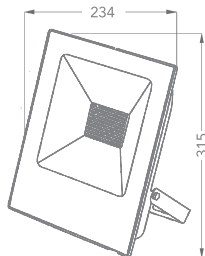

50W

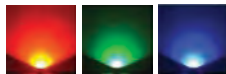

Model	FL-SMD-20	FL-SMD-50
Power	20	50
Luminous flux	16000	32000
CCT(K)	RGB	
Input Voltage	90~265VAC 50-60Hz	
CRI	80	



Flood light

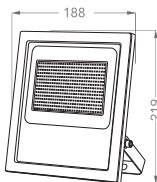

50W

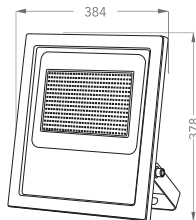

300W

Model	X3 FINISH	
Power	50	300
Luminous flux	85	85
CCT(K)	7000K	
Input Voltage	90~265VAC 50-60Hz	
CRI	80	





Flood light

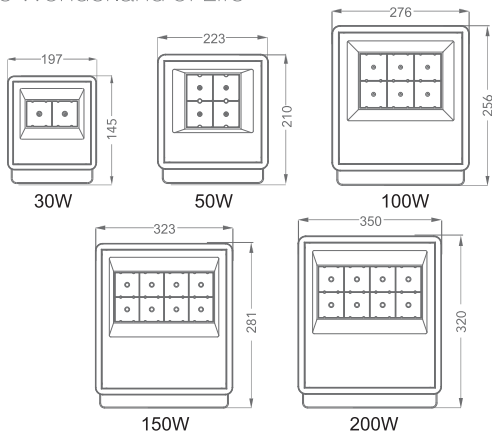

Model	GF01-PRO-BWG				
Power	30	50	100	150	200
Luminous flux	3000	5000	10000	15000	20000
CCT(K)	3000 / 6500				
Input Voltage	90~265VAC 50-60Hz				
CRI	80				



Flood light

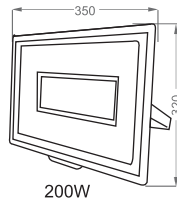
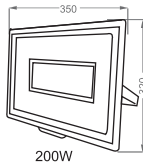
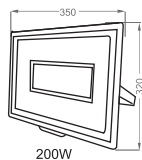
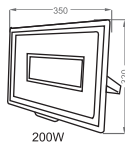

Model

**T036**

Power

**50**

**100**

**150**

**200**

Luminous flux

**3923**

**7985**

**12358**

**15986**

CCT(K)

**3000 / 8000**

Input Voltage

**100~240VAC 50-60Hz**

CRI

**80**





**LED  
HIGH BAY  
SERIES**



LED HIGH BAY LIGHT

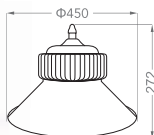

150W

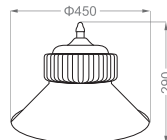

200W

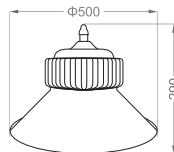

250W

Model	<b>SH-GKD2</b>		
Power	<b>150</b>	<b>200</b>	<b>250</b>
Luminous flux	<b>10000 / 12000</b>	<b>16000</b>	<b>18000</b>
CCT(K)	<b>3000 / 6500</b>		
Input Voltage	<b>85~265VAC 50-60Hz</b>		
CRI	<b>80</b>		



LED HIGH BAY LIGHT

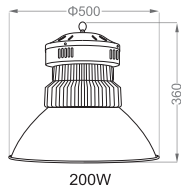
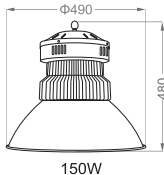
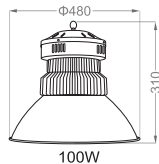
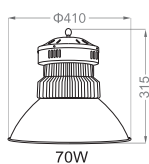
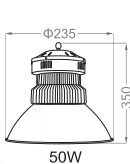

Model

**SH-GTD**

Power

50

100

150

200

250

Luminous flux

4500

9000

12000

16000

20000

CCT(K)

6500

Input Voltage

90~265VAC 50-60Hz

CRI

80



LED HIGH BAY LIGHT

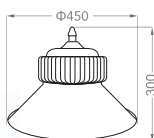

150W

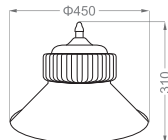

150W

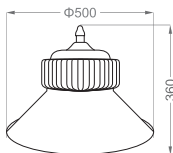

200W /250W

Model

**SH-GKD**

Power

**100**

**150**

**200**

**250**

Luminous flux

**9000**

**9000**

**16000**

**18000**

CCT(K)

**6500**

Input Voltage

**85~265VAC 50-60Hz**

CRI

**80**



**IP 65**



LED HIGH BAY LIGHT

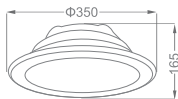

100W

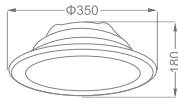

150W

Model	LPHB	
Power	100	150
Luminous flux	9000	13500
CCT(K)	7000	
Input Voltage	85~265VAC 50-60Hz	
CRI	80	





**TRACK LIGHT  
SERIES**



LED Track Light



Track light LED

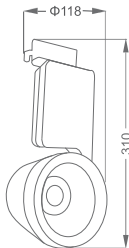

30W

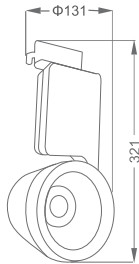

35W

Model	TSM-900	TSM-1000
Power	30	35
Luminous flux	2283	3150
CCT(K)	7000	
Input Voltage	100~265VAC 50-60Hz	
CRI	80	



**TOOLS  
SERIES**

Voltage Tester



Model	S93	S63
Length	190	145
Voltage Tester AC	100V~500V	
Material of Blade	CRV Material / 48-58 HRC	
Material of Handle	AS	
Standard	30000	

A photograph of two white swans swimming in dark water, overlaid with a semi-transparent purple filter. The swans are positioned in the center-left and center-right of the frame, facing each other. The water shows ripples and reflections.

**LED  
DECORATIVE**

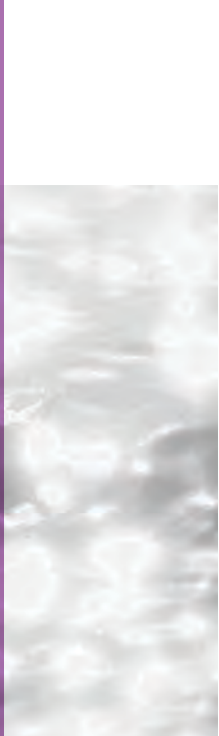

LED DECORATIVE

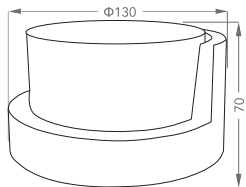

Model

FH-WPL216

Power

7

Luminous flux

560

CCT(K)

3000K / 7000K

Input Voltage

175~265VAC 50-60Hz

CRI

80



IP 54

LED DECORATIVE

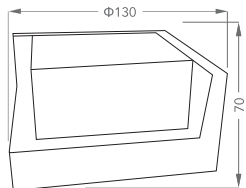

Model

FH-WPL217

Power

7

Luminous flux

960

CCT(K)

3000K / 7000K

Input Voltage

175~265VAC 50-60Hz

CRI

80



IP 54



LED DECORATIVE

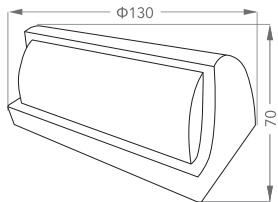

Model

FH-WPL218

Power

20

Luminous flux

1600

CCT(K)

3000K / 7000K

Input Voltage

175~265VAC 50-60Hz

CRI

80



IP 54

LED DECORATIVE

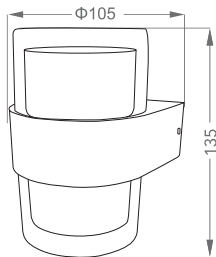

Model

FH-WPL219S

Power

2x7

Luminous flux

1120

CCT(K)

3000K / 7000K

Input Voltage

175~265VAC 50-60Hz

CRI

80



IP 54

LED DECORATIVE

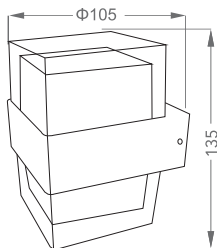

Model

FH-WPL220S

Power

2x7

Luminous flux

1120

CCT(K)

3000K / 7000K

Input Voltage

175~265VAC 50-60Hz

CRI

80



IP 54



The Wonderland of Life  
Power**enzo**.com

---

 Baghdad

 0773 5971985

---

 Erbil

 009647501376952

---

 Sulaimaniyah

 0 7 7 3 0 0 0 3 1 9 4  
009647721520600

---